

Mono 500 Electric Freestanding Screen Mount - 8425

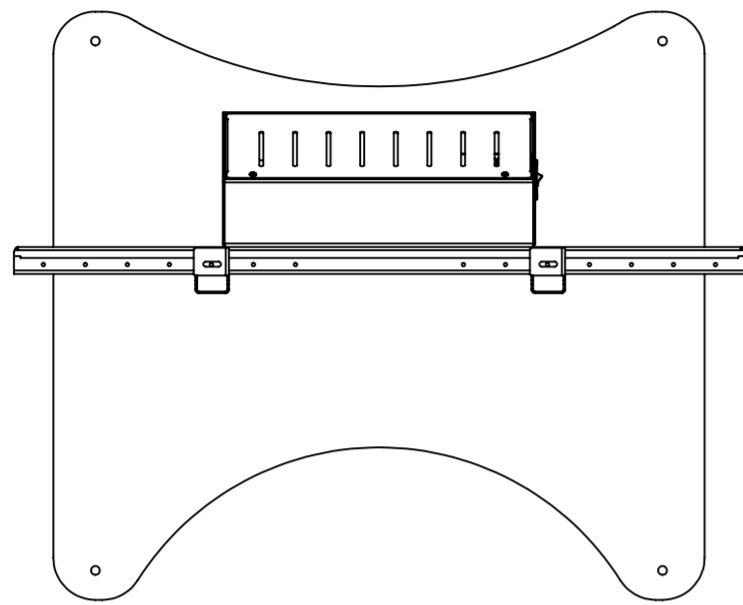

- Max Capacity 130KG, suitable for screens between 42 and 86in
- Suitable for VESA mounts 200, 300, 400, 500, 600, 700 and 800mm in width and between 100 and 600mm in height
- 500mm Electric height adjustment, 850-1350mm Height range to center of mount.
- 4 Gang UK power and 2 x IEC power sockets included inside headbox
- Anti-Collision sensor
- Freestanding plate can be bolted down for additional stability if required

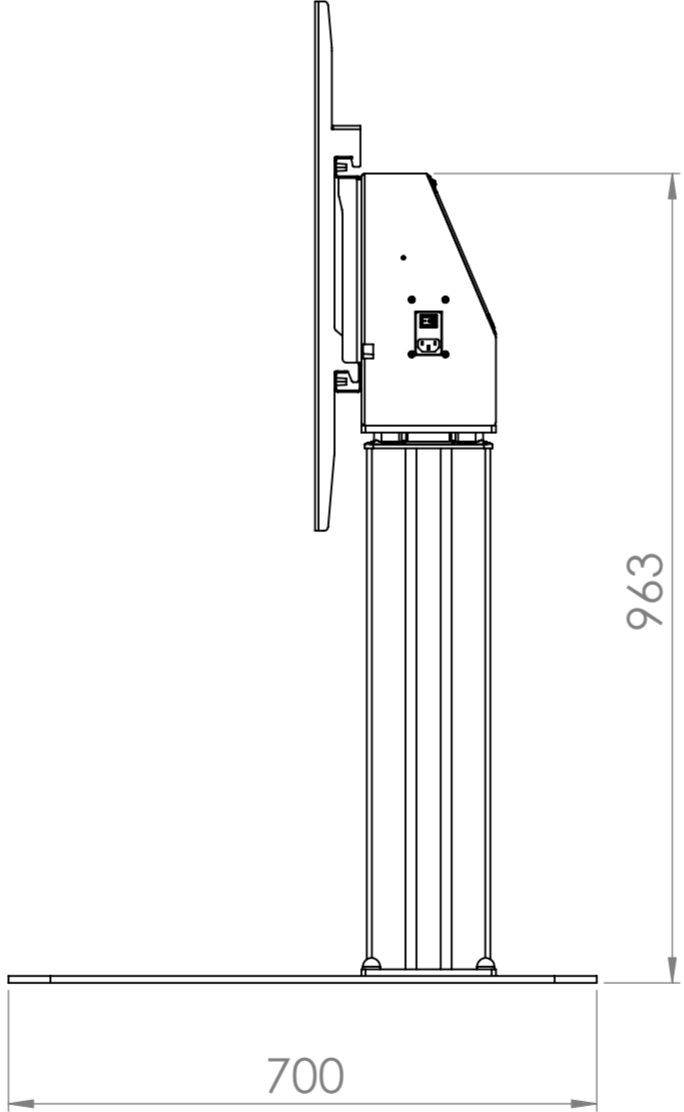
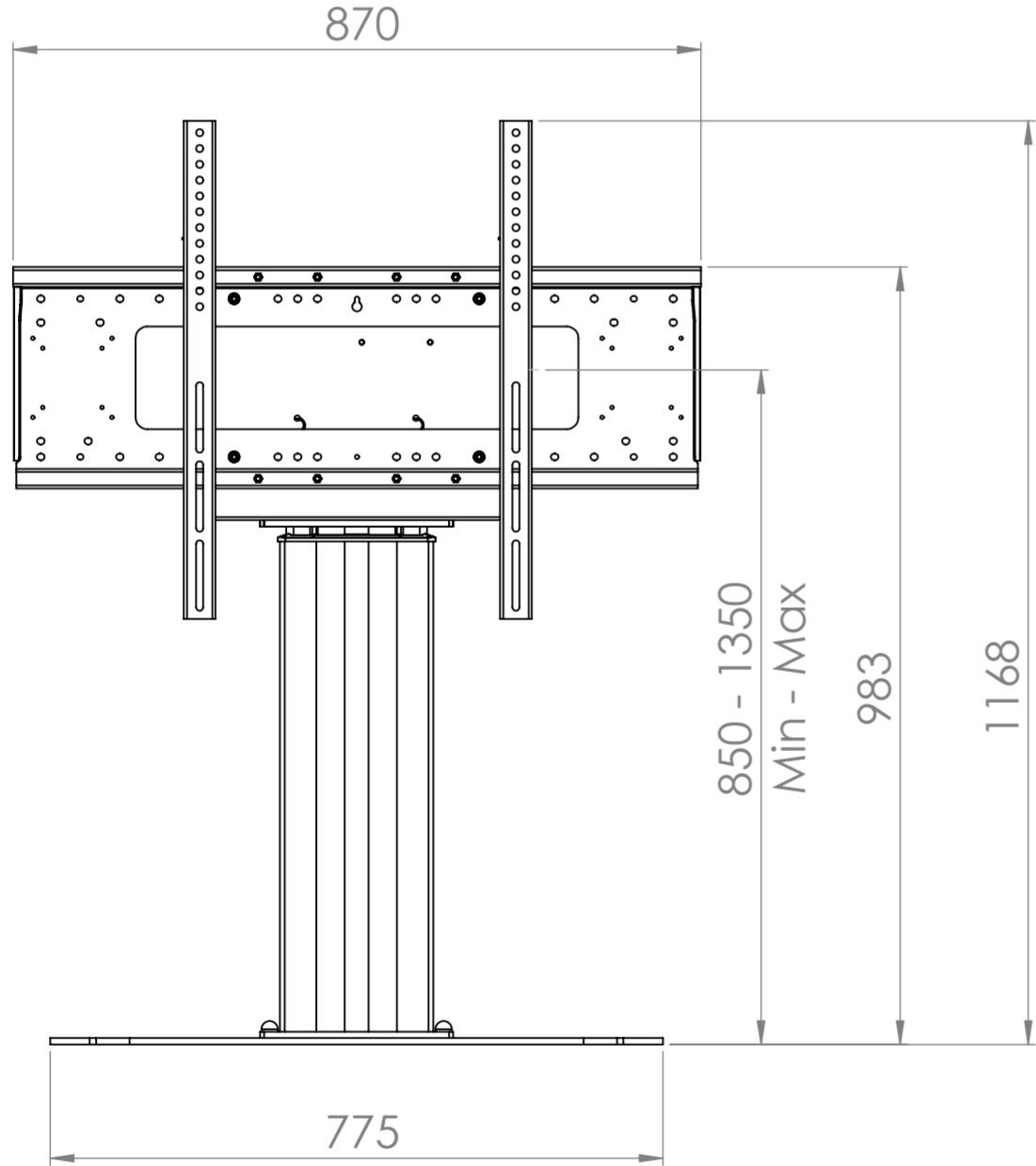
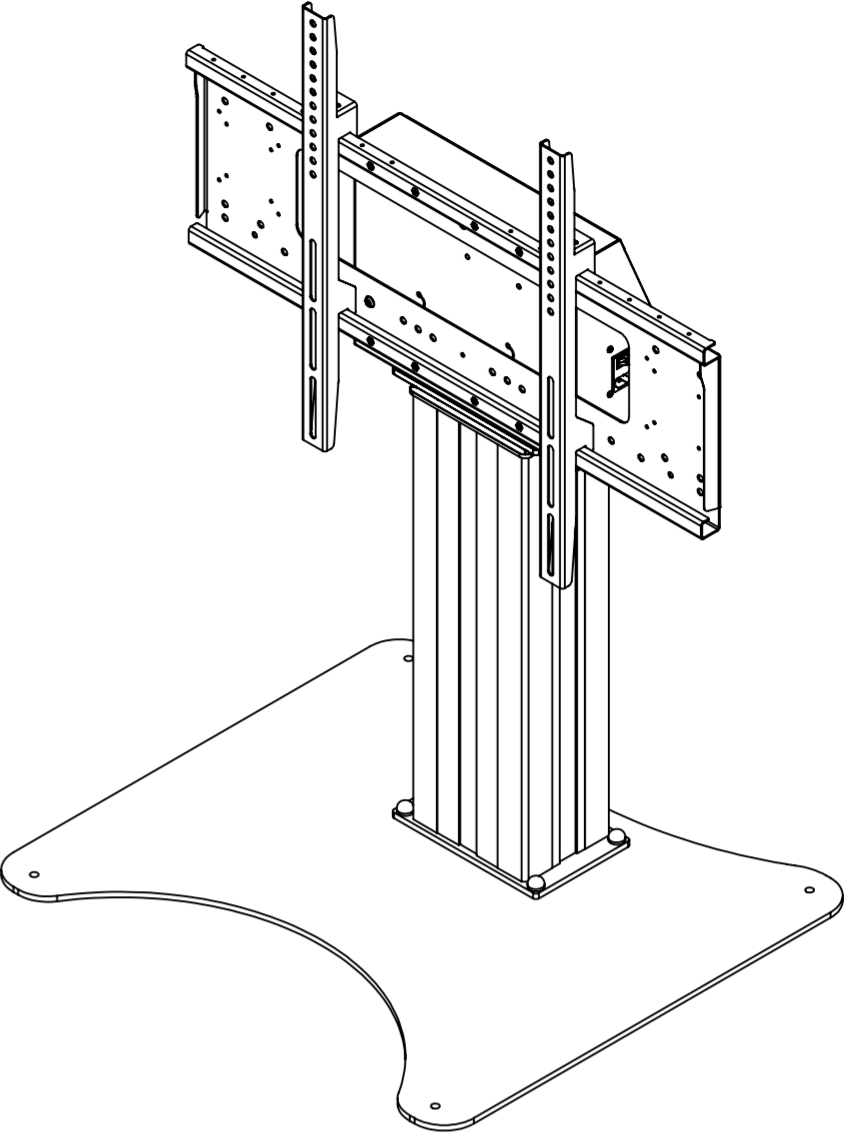

* Stand shown in lowest position



LOXIT
PRODUCTS

Loxit Limited
First avenue
Poynton Industrial Estate
Poynton
Cheshire
England
SK12 1YJ
t: +44 (0) 845 519 5191
w: www.loxit.com

The copyright of this drawing is retained by Loxit limited
This drawing may not be reproduced without prior written permission of Loxit limited

*Dimensions given to a tolerance of +-3mm