

ActivBoard 300 Pro Adjustable System

INTERACTIVE DISPLAY

PRODUCT SPECIFICATIONS



ActivBoard 300 Pro Adjustable System with PRM-45 Projector



ActivBoard 300 Pro Adjustable System with EST-P1 projector



ActivBoard 300 Pro Adjustable System with UST-P1 projector

THIS DOCUMENT CONTAINS SPECIFICATIONS FOR

ActivBoard 300 Pro Series Adjustable System

DESCRIPTION

The ActivBoard 300 Pro is available in 78", 87" and 95" versions. Please see the ActivBoard 300 Pro Specification Sheet for details. The Adjustable System includes a height adjustable wall mount and choice of extreme short throw, ultra short throw, or short throw projector. Please see the Stands specification sheet and the Projectors specification sheet for details.

SYSTEM OVERVIEW

Installation

The installation of this product should be completed by a Promethean trained installer. Components supplied and minimum specifications stated have been tested and are required for optimal performance. Use of components not supplied by Promethean or not meeting minimum specifications may impact performance and affect warranty.

Contact your Promethean partner or visit www.PrometheanKB.com for more information.

Warranty

For Promethean Warranty Terms and Conditions please visit: www.PrometheanWorld.com/ActivCare

Support

Online Support for all Promethean Products available from: www.PrometheanKB.com

Complete System Weight (approx.)

ActivBoard 378 Pro including:
PRM-45 Projector 83.2kg (183.5lb)
UST-P1 Projector 84.8kg (187.0lb)
EST-P1 Projector 87.3kg (192.5lb)

ActivBoard 387 Pro including:
PRM-45 Projector 85.7kg (188.0lb)
UST-P1 Projector 87.3kg (192.6lb)
EST-P1 Projector 89.8kg (198.0lb)

ActivBoard 395 Pro including:
PRM-45 Projector 89.7kg (197.8lb)
UST-P1 Projector 91.3kg (201.4lb)
EST-P1 Projector 93.8kg (206.8lb)

AB300ProAdjustableSystem 09/14 V1.1

Page 1

TECHNICAL DRAWING SPECIFICATIONS

ActivBoard 300 Pro Series with PRM-45 Projector Technical drawing and measurements

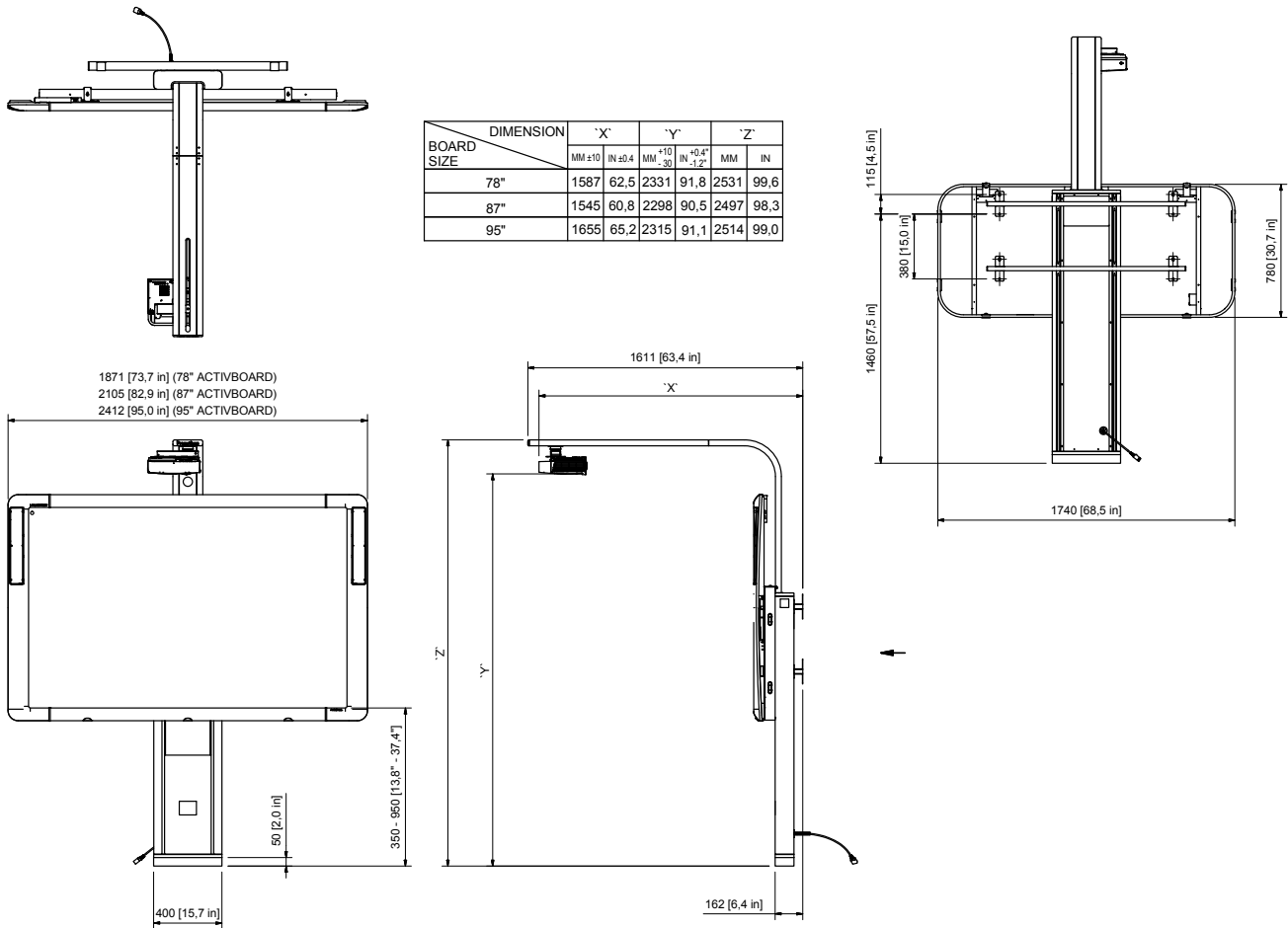

TECHNICAL DRAWING SPECIFICATIONS

ActivBoard 300 Pro Series with EST-P1 Projector
 Technical drawing and measurements

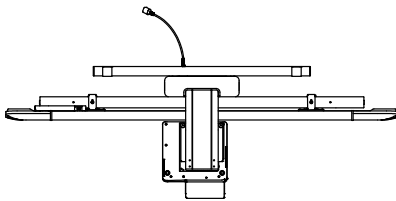

BOARD SIZE	DIMENSION						
	'X'	'Y'	'Z'	MM	IN	MM	IN
78"	726	28,6	2200	86,6	2510	98,8	
87"	708	27,9	2232	87,9	2543	100,1	
95"	747	29,4	2329	91,7	2639	103,9	

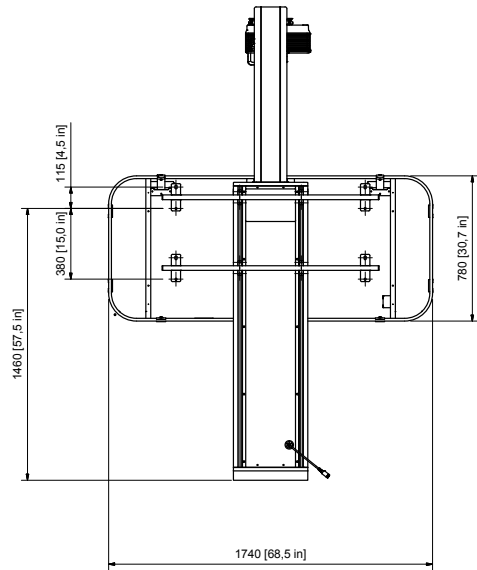
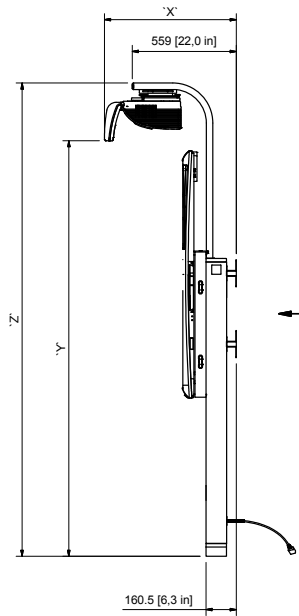
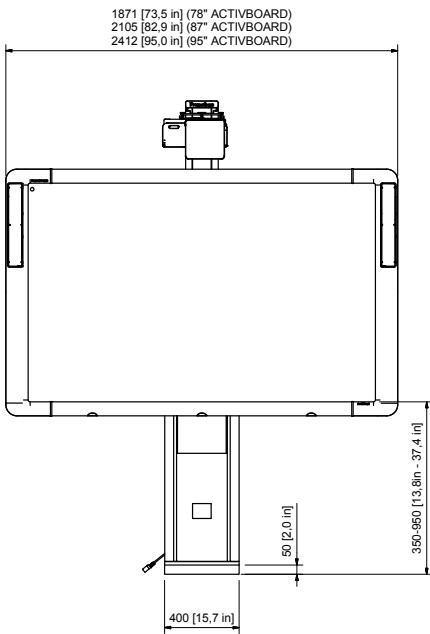

ActivBoard 300 Pro Adjustable System

INTERACTIVE DISPLAY

PRODUCT SPECIFICATIONS

TECHNICAL DRAWING SPECIFICATIONS

ActivBoard 300 Pro Series with UST-P1 Projector
 Technical drawing and measurements

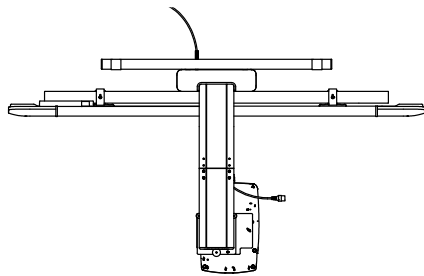

1870 [73.6 in] (78" ACTIVBOARD)
 2105 [82.9 in] (87" ACTIVBOARD)
 2412 [95.0 in] (95" ACTIVBOARD)

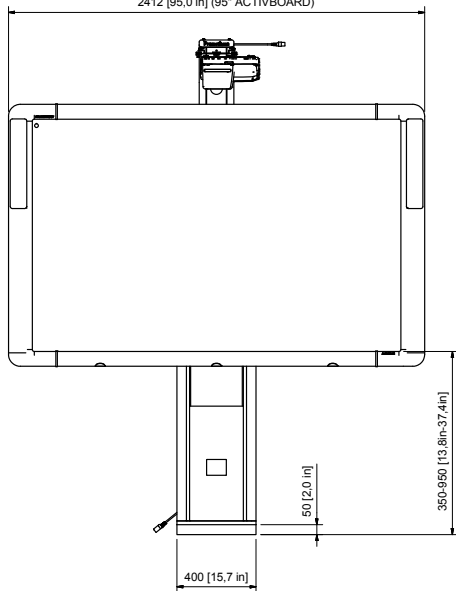

BOARD SIZE	'X'		'Y'		'Z'	
	MM±10	IN±0.4	MM ⁺¹⁰ ₋₃₀	IN ^{+0.4} _{-1.2}	MM	IN
78"	1020	40.1	2254	88.7	2502	98.5
87"	988	38.9	2241	88.2	2488	98.0
95"	1081	42.6	2270	89.4	2517	99.1

